

# Low Voltage Operating 75Ω Driver Monolithic IC MM1671~MM1677 Series

July 8, 2003

## Outline

This IC is a 75Ω driver with a built-in LPF that can operate at low voltage. Operating supply voltage supports 3V and 5V systems, and it is ideal for video signal output in devices ranging from portable equipment such as digital still cameras to stationary equipment such as DVD players. It incorporates a high-performance 4th-order LPF, which is ideal for removing DAC sampling noise. In addition, ultra-low current consumption has been achieved by suppressing current consumption in power-save mode to under 1μA. This lengthens battery life in portable devices.

The built-in amp gain on these series ICs is available: 6dB/9dB/12dB/16.5dB, thus enabling support for DAC and a variety of output amplitudes. The series offers a choice of either with or without input clamp, allowing support for a range of video signals, other than composite signals.

## Line-up

Model Name	Clamp	Built-in amplifier	SAG measures pin	Power supply voltage
MM1671	○	6dB	○	2.8~5.5V
MM1672	○	9dB	○	2.8~5.5V
MM1673	○	12dB	○	2.8~5.5V
MM1674	×	6dB	○	2.8~5.5V
MM1675	×	9dB	○	2.8~5.5V
MM1676	×	12dB	○	2.8~5.5V
MM1677	○	16.5dB	○	2.8~5.5V

## Features

1. Operating supply voltage 2.8~5.5V (supports 3V and 5V systems)
2. Operating ambient temperature -40~85°C
3. Current consumption (no signal) 7.0mA typ.
4. Current consumption in power-save mode 1.0μA max.
5. High-precision voltage gain 6±0.3dB at 100kHz (MM1671)
6. Includes a high-performance 4th-order LPF 6.75MHz/100kHz max. ±1.0dB  
27MHz/100kHz typ. -40dB
7. Incorporates a sag auxiliary circuit
8. Built-in amp output gain available in these series models (6dB/9dB/12dB/16.5dB)
9. The series offers a choice of either with or without input clamp.
10. Mounted in a ultra-small package

## Package

SOT-26A

## Pin Assignment

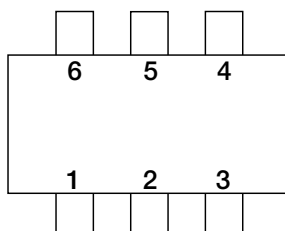

SOT-26A  
(TOP VIEW)

1	PS
2	OUT
3	SAG
4	IN
5	GND
5	Vcc

## Block Diagram

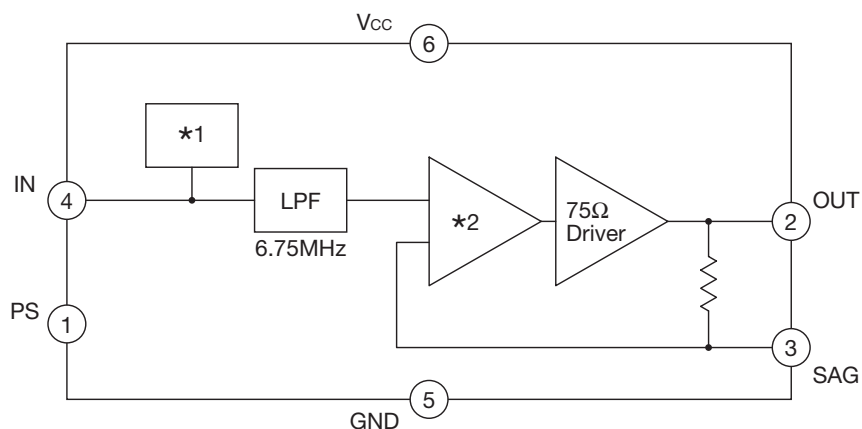

	*1 Input Clamp		*2 Built-in amplifier			
	bias	clamp	6dB (*2)	9dB(*2)	12dB (*2)	16.5dB (*2)
MM1671		<input type="radio"/>	<input type="radio"/>			
MM1672		<input type="radio"/>		<input type="radio"/>		
MM1673		<input type="radio"/>			<input type="radio"/>	
MM1674	<input type="radio"/>		<input type="radio"/>			
MM1675	<input type="radio"/>			<input type="radio"/>		
MM1676	<input type="radio"/>				<input type="radio"/>	
MM1677		<input type="radio"/>				<input type="radio"/>

Pin Description

Pin no.	Pin name	Function	Internal equivalent circuit diagram
1	PS	Power save	
2	OUT	Signal output	
3	SAG	SAG correction	
4	IN	Signal input	
5	GND	GND	
6	Vcc	Vcc	

**Absolute Maximum Ratings** (Ta=25°C)

Item	Symbol	Ratings	Units
Storage temperature	T <sub>STG</sub>	-65~+150	°C
Operating temperature	T <sub>OPR</sub>	-40~+85	°C
Supply Voltage	V <sub>CC max.</sub>	7	V
Allowable loss	P <sub>d</sub>	200	mW

**Recommended Operating Conditions**

Item	Symbol	Ratings	Units
Operating temperature	T <sub>OPR</sub>	-40~+85	°C
Operating voltage	V <sub>CCOP</sub>	2.8~5.5	V

**Electrical Characteristics** (Except where noted otherwise, Ta=25°C, V<sub>CC</sub>=3V)

Item	Symbol	Measurement conditions	Min.	Typ.	Max.	Units
Supply current	I <sub>CC1</sub>	No signal		7	10	mA
Supply current (at power save mode)	I <sub>CC2</sub>	No signal, PS: ON			1	μA
Power save terminal input current	H	I <sub>PSH</sub> 1PIN V <sub>H</sub> =2.8V			360	μA
	L	I <sub>PSL</sub> 1PIN V <sub>L</sub> =0.2V			18	μA
Power save terminal input voltage	H	V <sub>PSH</sub>	2.0		V <sub>CC</sub>	V
	L	V <sub>PSL</sub>			0.5	V
Input terminal voltage	V <sub>IN</sub>	4PIN		1.2		V
Output terminal voltage	V <sub>OUT</sub>	2PIN	0.15	0.3	0.45	V
Voltage gain	G <sub>V</sub>	SIN wave: 1V, f=100kHz	5.7	6.0	6.3	dB
Frequency characteristic 1	f <sub>c1</sub>	SIN wave: 1V, 6.75MHz/100kHz	-1.0	0	1.0	dB
Frequency characteristic 2	f <sub>c2</sub>	SIN wave: 1V, 27MHz/100kHz		-40	-27	dB
Differential gain	DG	Staircase signal 1V		0.7	1.5	%
Differential phase	DP	Staircase signal 1V		0.7	1.5	°
Output dynamic range	DR	SIN wave: 100kHz, THD=1.0%	2.2	2.4		V
S/N	SN	BW: 100k~6MHz		74		dB
Group delay	t <sub>1</sub>	at 100kHz		50	80	ns
Group delay	Δt <sub>1</sub>	to 3.58MHz		4	10	ns
		to 4.43MHz		6	10	ns
		to 6MHz		12	20	ns

Measuring Circuit

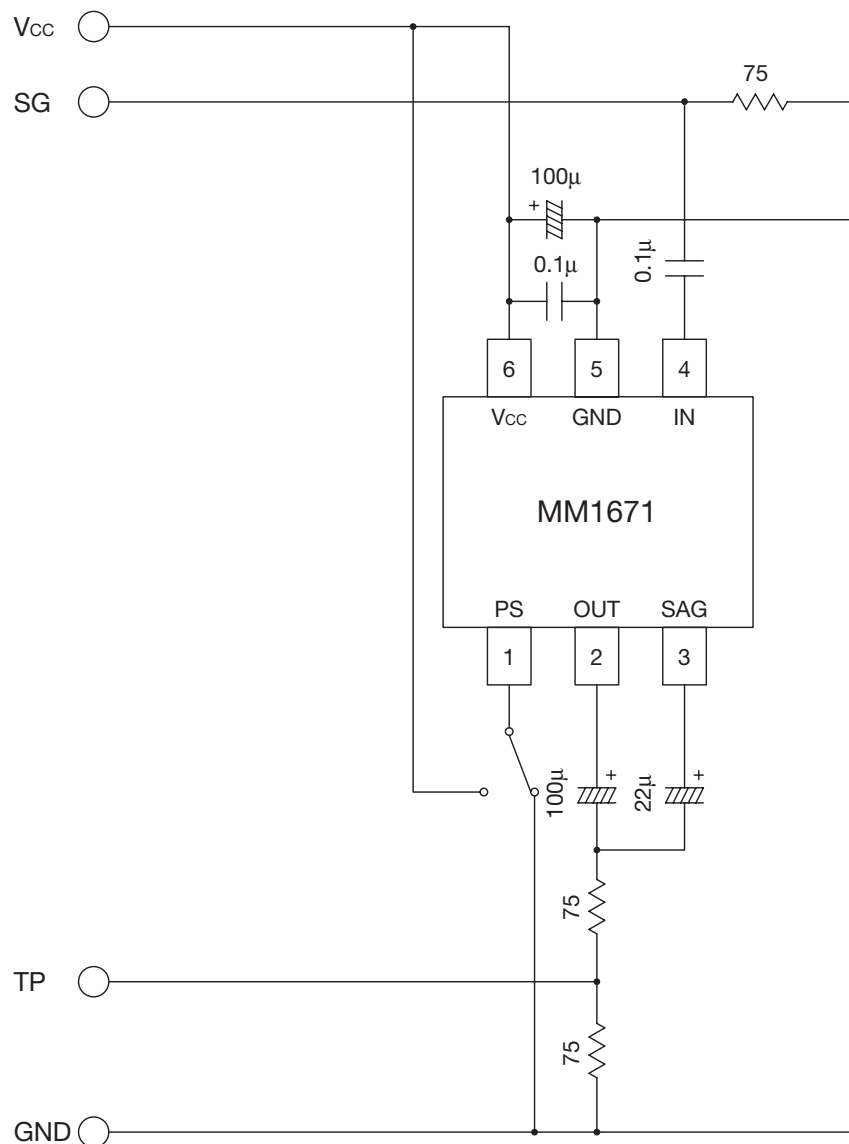

Switch Control Table

PS-Pin	Power save
H	OFF
L	ON
OPEN	ON

Application Circuit 1

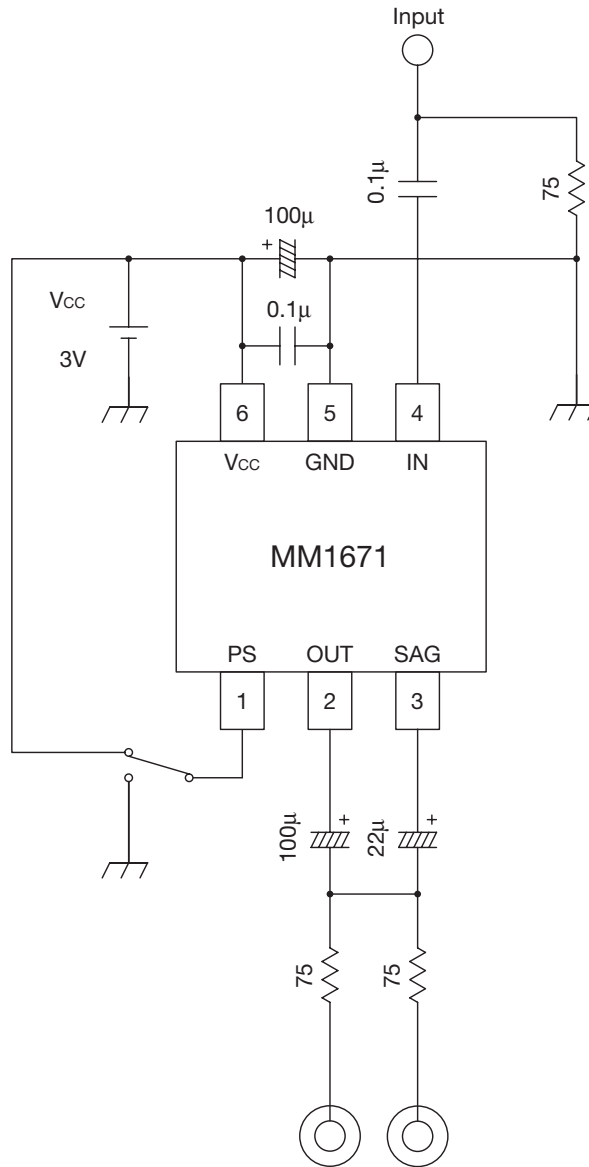

Application Circuit 2

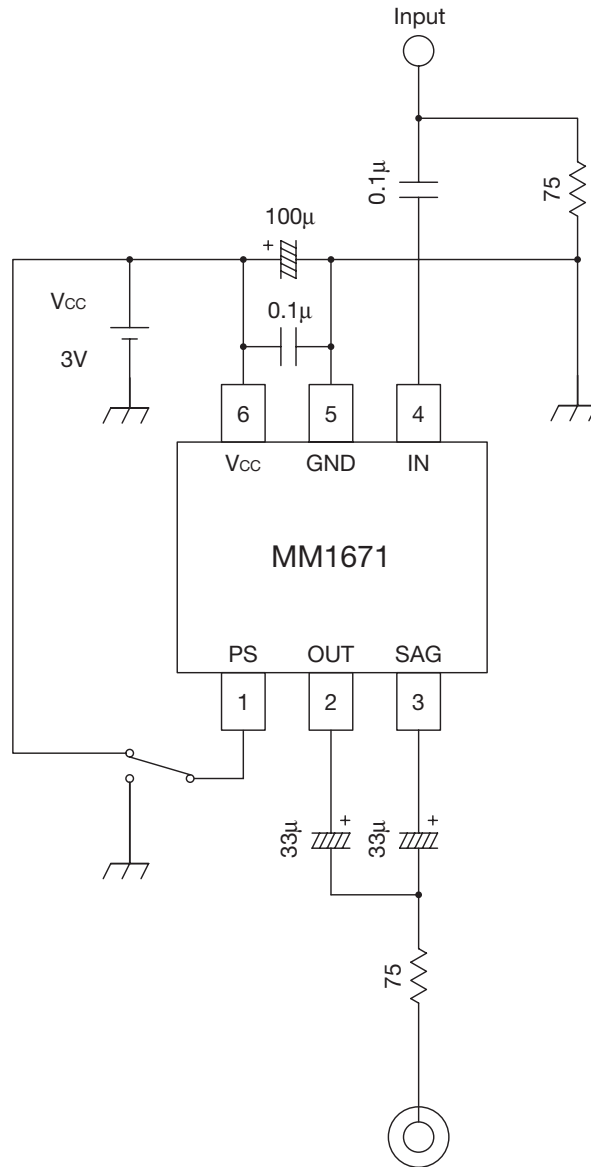

**Characteristics** (Except where noted otherwise,  $T_a=25^{\circ}\text{C}$ ,  $V_{CC}=3\text{V}$ )

■ Frequency Characteristic [log]

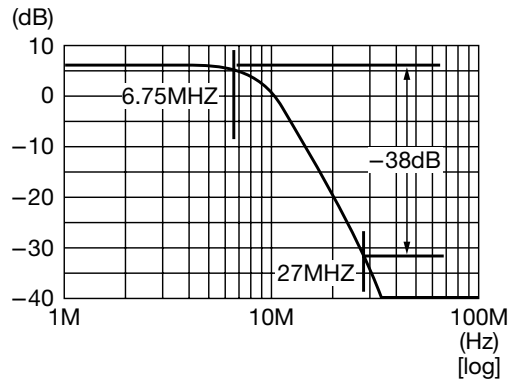

■ Frequency Characteristic [lin]

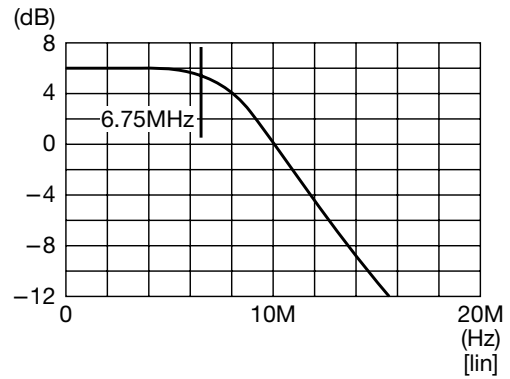

■ Group Delay [lin]

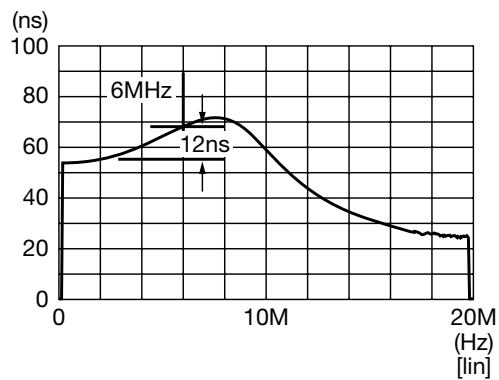

Note: There are typical characteristics. (Represent model MM1671XN)



**Characteristics** (Except where noted otherwise,  $T_a=25^\circ\text{C}$ ,  $V_{CC}=2.6\sim 6.0\text{V}$ )

■ Supply Current vs Supply Voltage

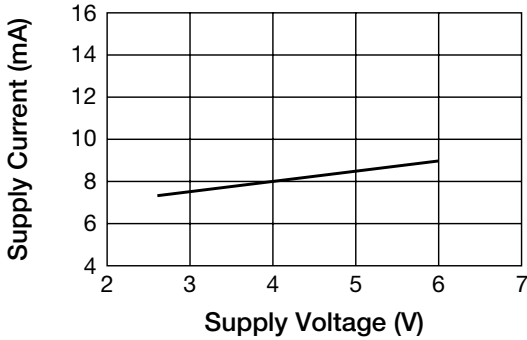

■ Supply Current vs Supply Voltage (at power save mode)

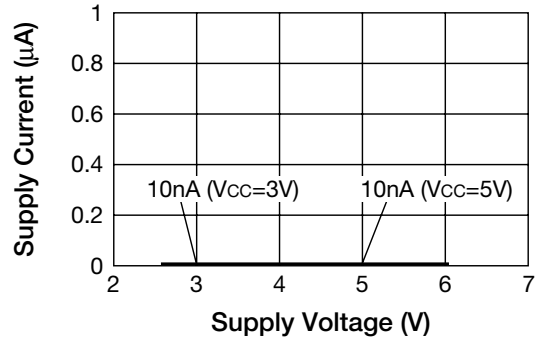

■ Input Terminal Voltage vs Supply Voltage

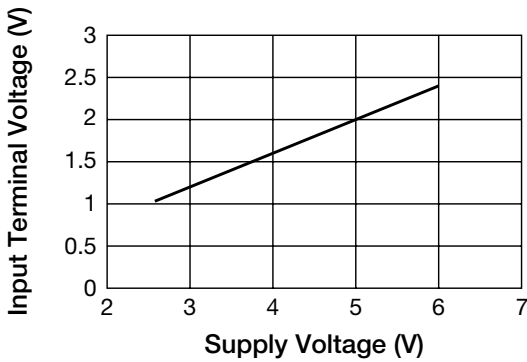

■ Output Terminal Voltage vs Supply Voltage

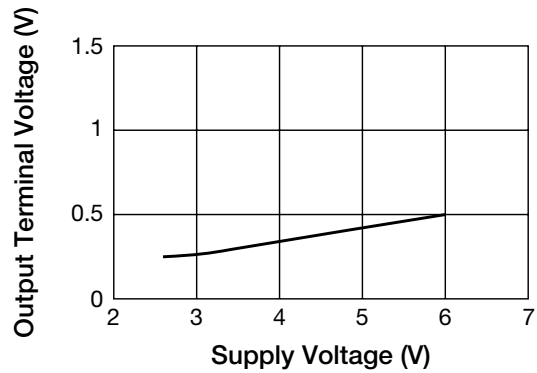

■ Differential Gain vs Supply Voltage

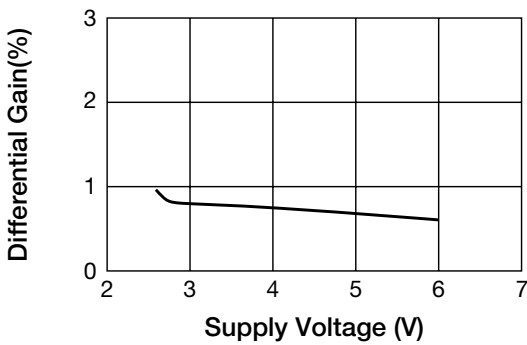

■ Differential Phase vs Supply Voltage

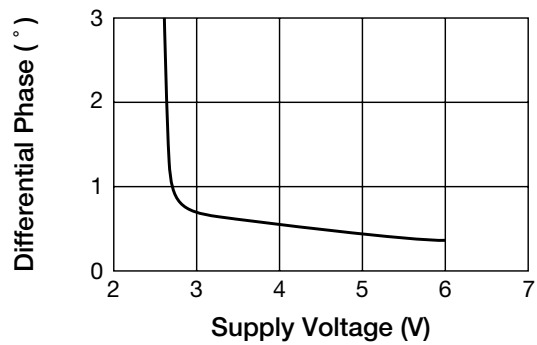

Note: There are typical characteristics. (Represent model MM1671XN)

■ Output Dynamic Range vs Supply Voltage ■ S/N vs Supply Voltage

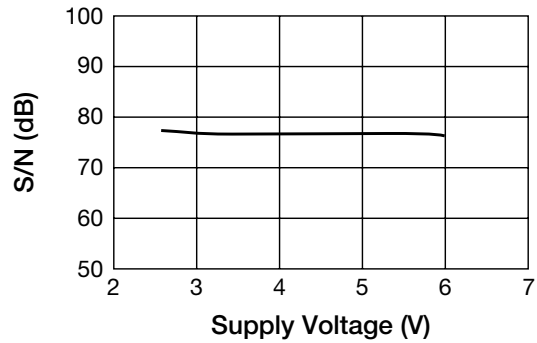
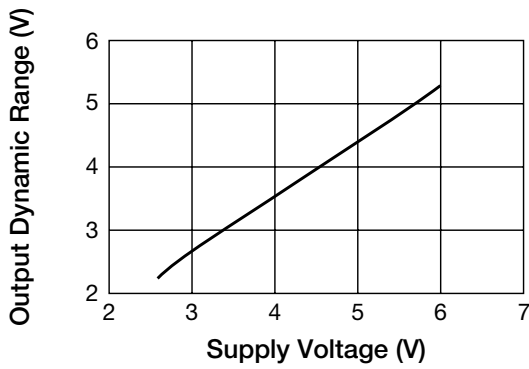

■ Voltage Gain vs Supply Voltage (f=100kHz) ■ Frequency Characteristic 1 vs Supply Voltage (f=6.75MHz/100kHz)

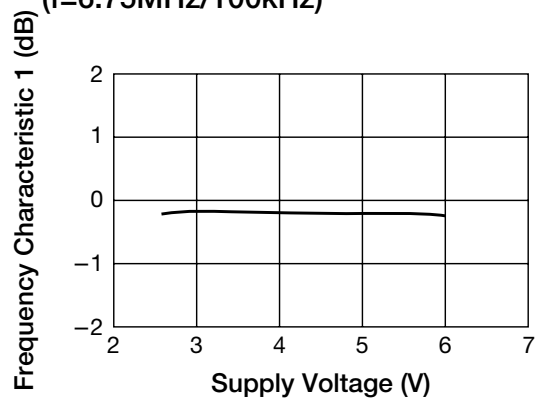
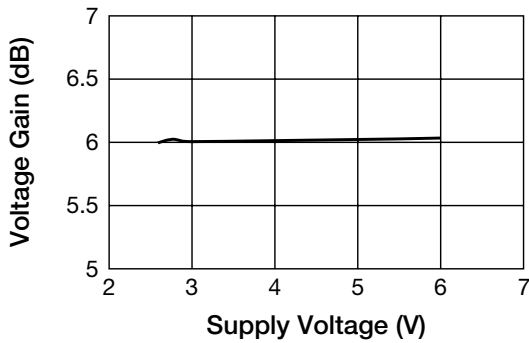

■ Frequency Characteristic 2 vs Supply Voltage (f=27MHz/100kHz)

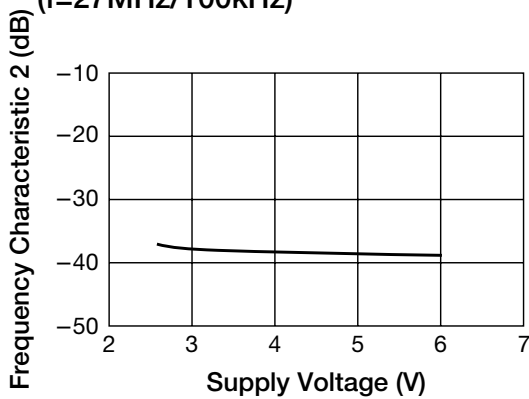

Note: There are typical characteristics. (Represent model MM1671XN)

**Characteristics** (Except where noted otherwise,  $T_a = -50 \sim 90^\circ\text{C}$ ,  $V_{CC} = 3\text{V}$ )

■ Supply Current vs Temperature

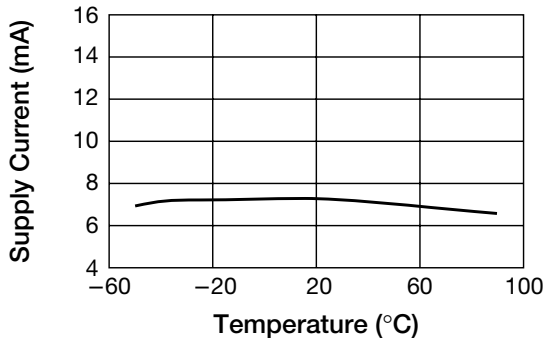

■ Supply Current vs Temperature (at power save mode)

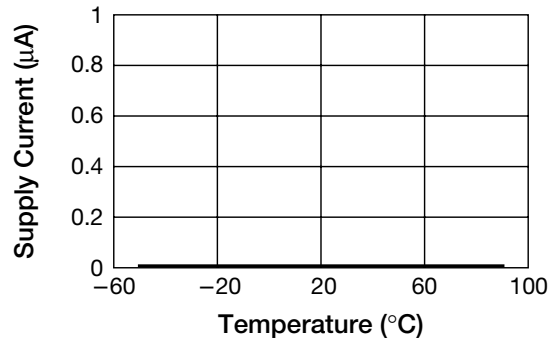

■ Input Terminal Voltage vs Temperature

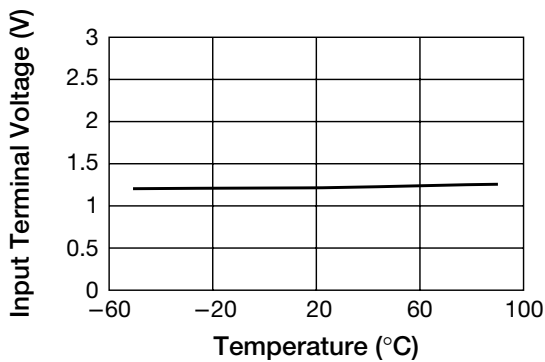

■ Output Terminal Voltage vs Temperature

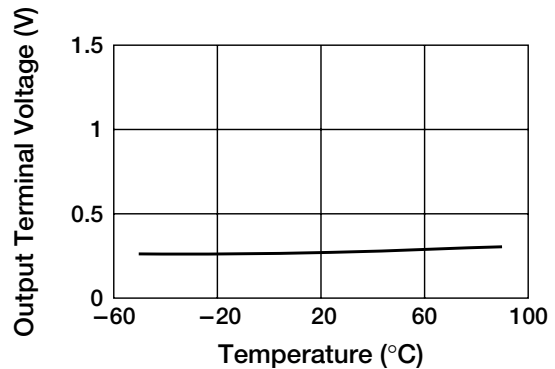

■ Differential Gain vs Temperature

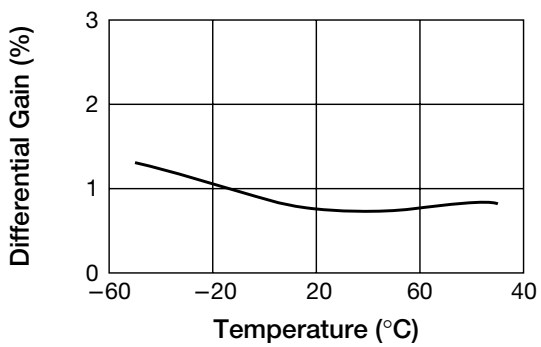

■ Differential Phase vs Temperature

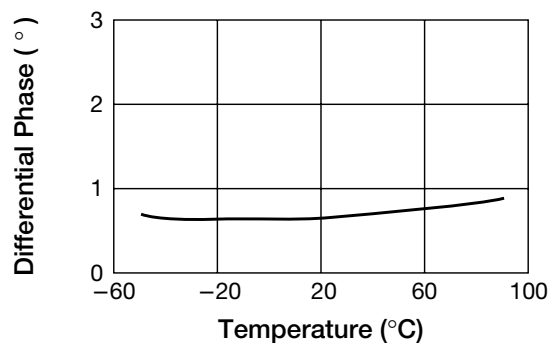

Note: There are typical characteristics. (Represent model MM1671XN)

■ Output Dynamic Range vs Temperature

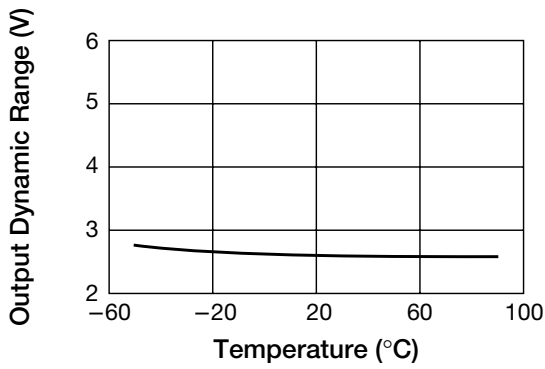

■ S/N vs Temperature

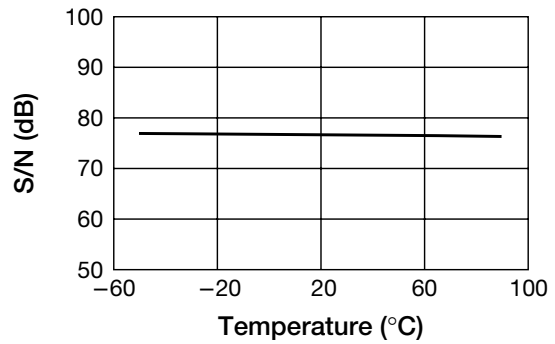

■ Voltage Gain vs Temperature (f=100kHz)

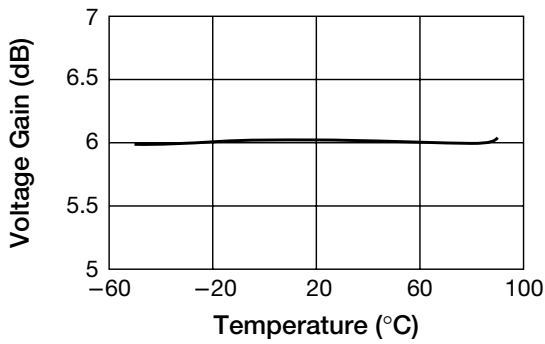

■ Frequency Characteristic 1 vs Temperature (f=6.75MHz/100kHz)

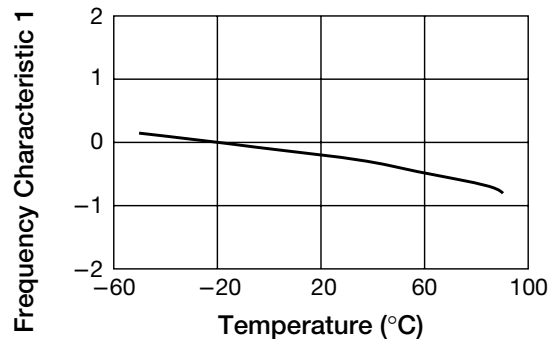

■ Frequency Characteristic 2 vs Temperature (f=27MHz/100kHz)

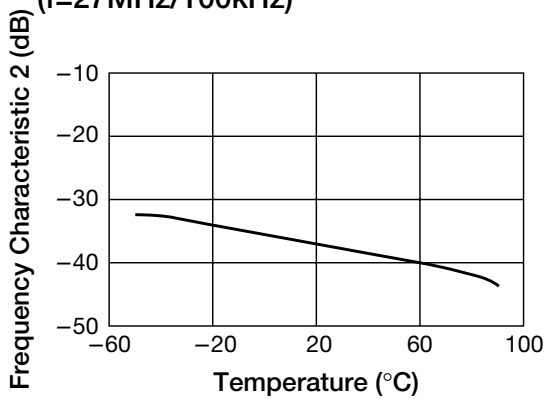

Note: There are typical characteristics. (Represent model MM1671XN)